



DG1720/DG1720P 17 – 20 GHz Zero Bias Schottky Detector

FEATURES

- ❖ Excellent Flatness vs. Frequency
- ❖ Mounting Holes Option
- ❖ Very High Sensitivity
- ❖ No Bias Required



SPECIFICATIONS

17 – 20 GHz Zero Bias Schottky Detector		
Parameter	Negative Polarity	Positive Polarity
Model Number	DG1720	DG1720P
Frequency Range	17 – 20 GHz	17 – 20 GHz
Sensitivity	2700 mV/mW Min.	2000 mV/mW Min.
Flatness vs. Frequency	±0.20 dB Typ.	±0.40 dB Typ.
TSS	-45 dBm Typ.	-45 dBm Typ.
Maximum Input Power	+20 dBm Typ.	+20 dBm Typ.
Output Polarity	Negative	Positive
Connector Type	SMA Female	SMA Female

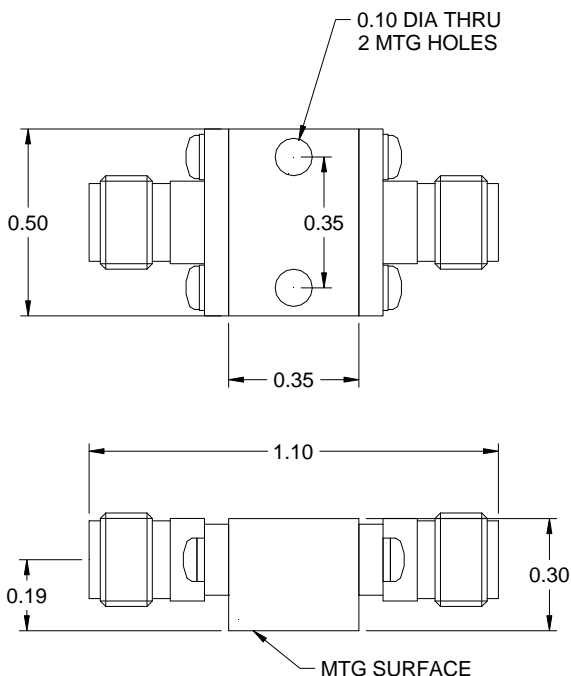

Design to meet the following environmental specifications: (verification optional)

1. Operating Temp: -55°C to +85°C
2. Storage Temp: -65°C to +125°C
3. Shock: MIL-STD-202F, M213, Cond B
4. Altitude: MIL-STD-202F, M105, Cond B
5. Vibration: MIL-STD-202F, M204, Cond B
6. Thermal Shock: MIL-STD-202F, M107, Cond A
7. Temp. Cycle: MIL-STD-202F, M105C, Cond D
8. Humidity: MIL-STD-202F, M103, Cond B (Optional with Hysol epoxy seal)

Standard Finishing: Rugged Aluminum Housing. Optional finishing with blue epoxy paint per MIL-C-22750 available on request to meet the humidity specification MIL-STD-202F, M103, Cond B

Note:

1. SMA male/female combination available on request
2. Part number for different SMA combination is as follow
Add "M" suffix for SMA male to male
Add "MF" suffix for SMA male to female
The performance may vary slightly when the RF connector changed to other type
3. The sensitivity is measured into an open circuit load (>10k Ohm)
4. Custom design for other frequency range and outline requirement available on request