



D81720 17 – 20 GHz 8-Way Power Divider/Combiner

FEATURES

- ❖ Low VSWR
- ❖ High Isolation
- ❖ Small Package
- ❖ Light Weight



SPECIFICATIONS

17 – 20 GHz 8-Way Power Divider/Combiner	
Model Number	D81720
Frequency Range	17 – 20 GHz
Insertion Loss	1.6 dB Typ., 2.2 dB Max.
Isolation	22 dB Typ., 18 dB Min.
Input VSWR	1.25:1 Typ., 1.35:1 Max.
Output VSWR	1.20:1 Typ., 1.30:1 Max.
Amplitude Balance	±0.25 dB Typ., ±0.40 dB Max.
Phase Balance	±3.0° Typ., ±6.0° Max.
Power Handling as Divider	50 W CW Max.
Impedance	50Ω
Connector Type	SMA (other connector available on request)

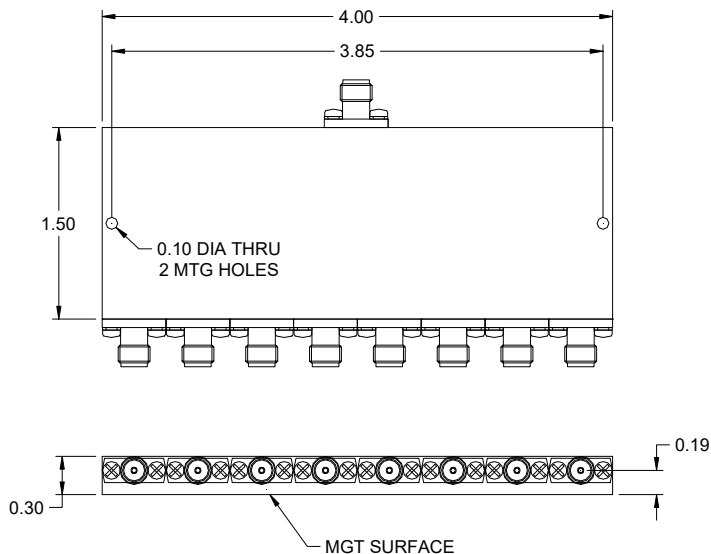

Design to meet the following environmental specifications: (verification optional)

1. Operating Temp: -55°C to +85°C
2. Storage Temp: -65°C to +125°C
3. Shock: MIL-STD-202F, M213, Cond B
4. Altitude: MIL-STD-202F, M105, Cond B
5. Vibration: MIL-STD-202F, M204, Cond B
6. Thermal Shock: MIL-STD-202F, M107, Cond A
7. Temp. Cycle: MIL-STD-202F, M105C, Cond D
8. Humidity: MIL-STD-202F, M103, Cond B
(Optional with Hysol epoxy seal)

Standard Finishing: Rugged Aluminum Housing, optional finishing with blue epoxy paint per MIL-C-22750 available on request.

Note:

1. Insertion loss refers to the sum of the output power to the input power
2. Standard connector is SMA female for all the ports
3. Other connector combination is available on request
4. Power handling is under the condition that all the outputs are connected to the loads with 1.25:1 or better VSWR and the unit is mounted with excellent heat sink