



C23740 37 – 40 GHz 20 dB Directional Coupler

FEATURES

- ❖ Low VSWR
- ❖ High Directivity
- ❖ Low Insertion Loss
- ❖ Small Package



SPECIFICATIONS

37 – 40 GHz 20 dB Directional Coupler	
Model Number	C23740
Frequency Range	37 – 40 GHz
Coupling Value ¹	20 ± 1.0 dB Max.
Amplitude Flatness ²	±0.3 dB Typ., ±0.6 dB Max.
Insertion Loss (excluding coupled power)	0.90 dB Typ., 1.50 dB Max.
Directivity	15 dB Typ., 12 dB Max.
Main Line Input VSWR	1.35:1 Typ., 1.50:1 Max.
Main Line Output VSWR	1.35:1 Typ., 1.50:1 Max.
Input Power Handling ³	20 W CW Max.
Impedance	50Ω
Connector Type	2.92 mm Female

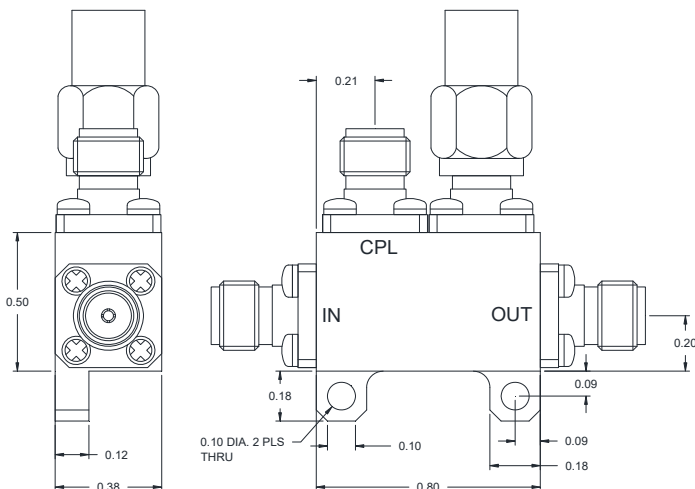

Design to meet the following environmental specifications: (verification optional)

1. Operating Temp: -55°C to +85°C
2. Storage Temp: -65°C to +125°C
3. Shock: MIL-STD-202F, M213, Cond B
4. Altitude: MIL-STD-202F, M105, Cond B
5. Vibration: MIL-STD-202F, M204, Cond B
6. Thermal Shock: MIL-STD-202F, M107, Cond A
7. Temp. Cycle: MIL-STD-202F, M105C, Cond D
8. Humidity: MIL-STD-202F, M103, Cond B
(Optional with Hysol epoxy seal)

Standard Finishing: Rugged Aluminum Housing, optional finishing with blue epoxy paint per MIL-C-22750 available on request.

Note:

1. Coupling refers to the input port
2. Deviation from the middle of the coupling value
3. Power handling is under the condition that all the outputs are connected to the loads with 1.25:1 or better VSWR and the unit is mounted with excellent heat sink