



C30108 1 – 8 GHz 30 dB Directional Coupler

FEATURES

- ❖ Low VSWR
- ❖ High Directivity
- ❖ Low Insertion Loss
- ❖ Small Package



SPECIFICATIONS

1 – 8 GHz 30 dB Directional Coupler	
Model Number	C30108
Frequency Range	1 – 8 GHz
Coupling Value	30 ± 1 dB Max.
Frequency Flatness	±0.50 dB Typ., ±0.70 dB Max.
Insertion Loss (excluding coupled power)	0.55 dB Typ., 0.75 dB Max.
Directivity	18 dB Typ., 14 dB Max.
Main Line Input VSWR	1.20:1 Typ., 1.351 Max.
Main Line Output VSWR	1.20:1 Typ., 1.351 Max.
Input Power Handling	50 W CW Max.
Impedance	50Ω
Connector Type	SMA Female (other options available on request)

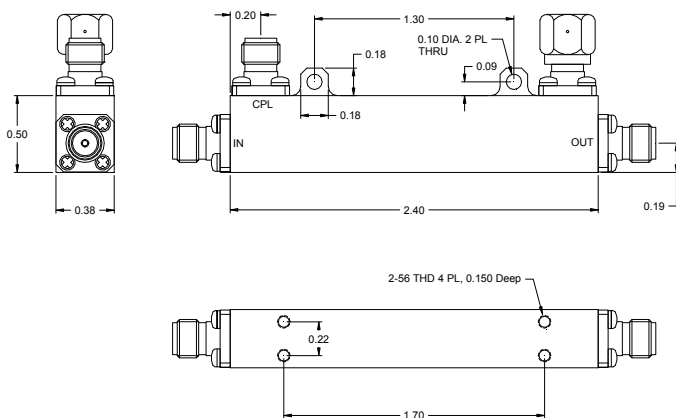

Design to meet the following environmental specifications: (verification optional)

1. Operating Temp: -55°C to +85°C
2. Storage Temp: -65°C to +125°C
3. Shock: MIL-STD-202F, M213, Cond B
4. Altitude: MIL-STD-202F, M105, Cond B
5. Vibration: MIL-STD-202F, M204, Cond B
6. Thermal Shock: MIL-STD-202F, M107, Cond A
7. Temp. Cycle: MIL-STD-202F, M105C, Cond D
8. Humidity: MIL-STD-202F, M103, Cond B (Optional with Hysol epoxy seal)

Standard Finishing: Rugged Aluminum Housing, optional finishing with blue epoxy paint per MIL-C-22750 available on request.

Note:

1. Coupling refers to the input port
2. Standard connector is SMA female for all the ports
3. Other connector combination is available on request
4. Power handling is under the condition that all the outputs are connected to the loads with 1.25:1 or better VSWR and the unit is mounted with excellent heat sink