



LT0204 2 – 4 GHz Limiter

FEATURES

- ❖ Low Insertion Loss
- ❖ Low VSWR
- ❖ Mounting Hole Option
- ❖ Customer Design Available



SPECIFICATIONS

2 – 4 GHz Limiter	
Model Number	LT0204
Frequency Range	2 – 4 GHz
Insertion Loss	0.30 dB Typ., 0.50 dB Max.
Input VSWR	1.15:1 Typ., 1.25:1 Max.
Output VSWR	1.15:1 Typ., 1.25:1 Max.
Peak Input Power	100 W Max.
CW Input Power	2 W Max.
Peak Flat Leakage	18 dBm Typ., 22 dBm Max.
CW Flat Leakage	15 dBm Typ., 18 dBm Max.
Impedance	50 ohm.
Connector Type	SMA Female (other connector available on request)

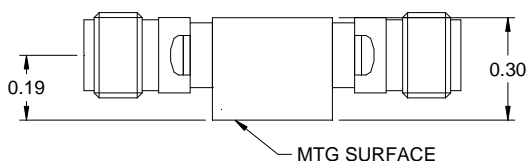
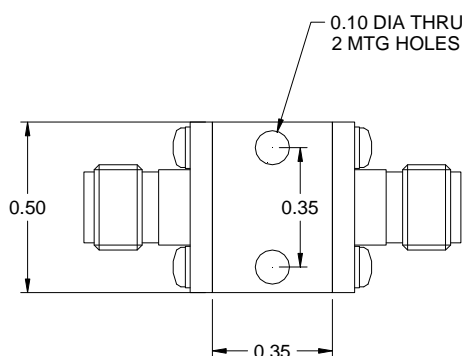

Design to meet the following environmental specifications (verification optional)

1. Operating Temp: -55°C to +85°C
2. Storage Temp: -65°C to +125°C
3. Shock: MIL-STD-202F, M213, Cond B
4. Altitude: MIL-STD-202F, M105, Cond B
5. Vibration: MIL-STD-202F, M204, Cond B
6. Thermal Shock: MIL-STD-202F, M107, Cond A
7. Temp. Cycle: MIL-STD-202F, M105C, Cond D
8. Humidity: MIL-STD-202F, M103, Cond B (Non-standard, optional with Hysol epoxy seal)

Standard Finishing: Rugged aluminum housing, optional finishing with blue epoxy paint per MIL-C-22750 available on request.

Note:

1. SMA male/female combination available on request
2. Part number for different SMA combination is as follow
Add "M" suffix for SMA male to male
Add "MF" suffix for SMA male to female
3. Other connector type available on request
4. The CW Leakage is measured at 1W input power
5. Power handling is linearly derated from full power at 25 °C to zero at +150 °C with excellent heat sink