



**D527 DC – 27 GHz Star Style 5-Way Resistive Power Divider**

**FEATURES**

- ❖ Outstanding Amplitude and Phase Balance
- ❖ Small Size with Mounting Holes
- ❖ Low Insertion Loss
- ❖ Low VSWR



**SPECIFICATIONS**

<b>DC – 27 GHz Star Style 5-Way Resistive Power Divider</b>	
Model Number	D527
Frequency Range	DC – 27 GHz
Nominal Power Splitting Loss	14 dB
Insertion Loss Above Splitting Loss	1.70 dB Typ., 2.30 dB Max.
Input VSWR	1.70:1 Typ., 1.90:1 Max.
Output VSWR	1.70:1 Typ., 1.90:1 Max.
Amplitude Balance	$\pm 0.35$ dB Typ., $\pm 0.60$ dB Max.
Phase Balance	$\pm 4.0^\circ$ Typ., $\pm 9.0^\circ$ Max.
Power Handling As Divider	1 W CW
Connector Type	SMA Female

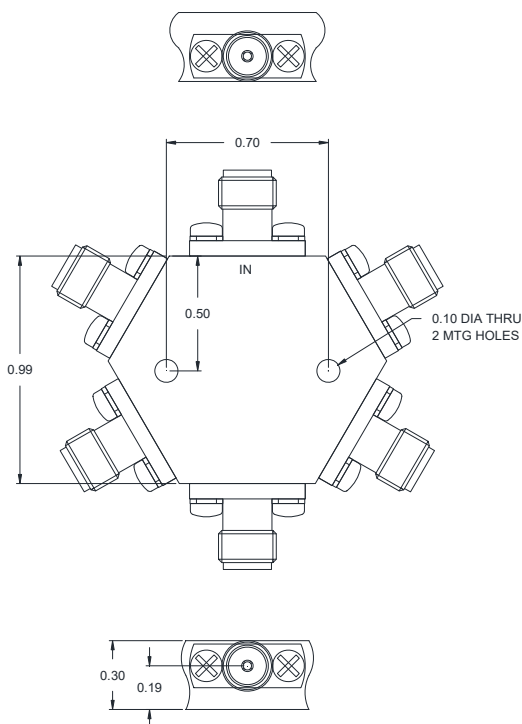

Design to meet the following environmental ratings: (verification optional)

1. Operating Temp: -55°C to +85°C
2. Storage Temp: -65°C to +125°C
3. Shock: MIL-STD-202F, M213, Cond B
4. Altitude: MIL-STD-202F, M105, Cond B
5. Vibration: MIL-STD-202F, M204, Cond B
6. Thermal Shock: MIL-STD-202F, M107, Cond A
7. Temp. Cycle: MIL-STD-202F, M105C, Cond D
8. Humidity: MIL-STD-202F, M103, Cond B  
(Optional with Hysol epoxy seal)

Standard Finishing: Rugged Aluminum Housing.  
Optional finishing with blue epoxy paint per MIL-C-22750 available on request.

Note:

1. The standard connector is SMA female, other connector available on request, performance may be slightly different
2. Insertion loss is average loss of all channels above nominal loss
3. Power handling is under the condition that all outputs are connected to the loads with 1.1:1 or better VSWR and the unit is mounted with excellent heat sink